

Data Sheet



Article number: 201017096

Description: E+G Clamping jaw blank GN 872-40-70

Measures

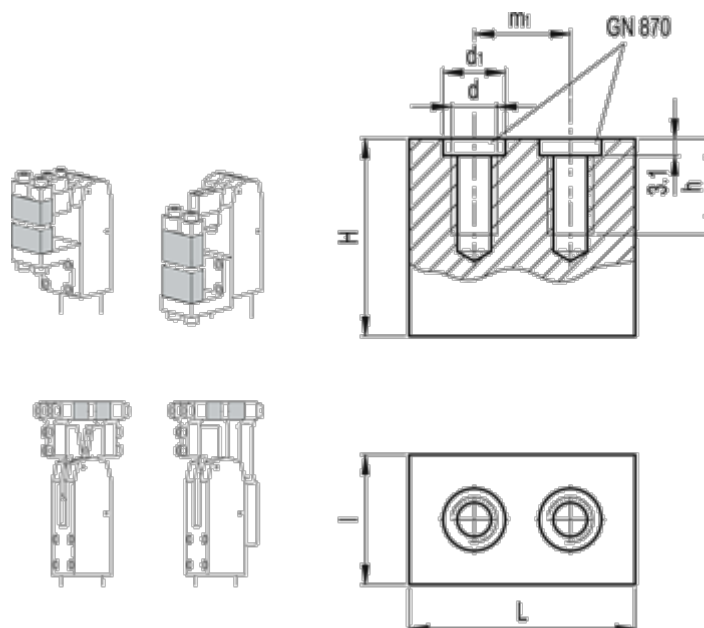

d = M8

d1 H8/h6 = 11

h = 17

H = 70

l = 17

L = 40

m1 = 23

Weight (g) = 350